

Article number: 12713000040700

Description: KLEE-coil 713 000 040.700
M4 Light-alloy metal

Measures

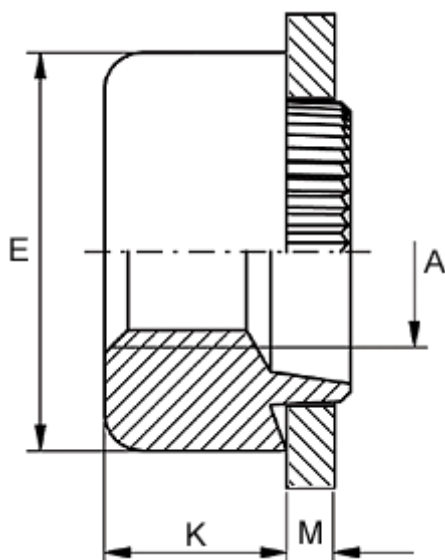

Female thread A	= M4
Height K	= 4.0
Outer diameter E	= 10.0
Plate thickness	= 3.5 to 3.7
Recommended bore diameter for extreme load	= 7.0
Recommended bore diameter for normal use	= 7.0